



MICAL ROMANO
RESTAURANT DESIGN
FALL 2010



feuer und eis

Client Profile and Concept Statement

FEUER und EIS is a sophisticated fondue restaurant and bar located in Atlantic City, NJ. The restaurant offers a wide range of cheese, meat, and dessert fondue options and also emphasizes an extensive bar. The owners of the restaurant wish to attract casino-goers, romantic vacationers, and local adults.

The concept for the FEUER UND EIS restaurant and bar will reflect the night life atmosphere of Atlantic City, NJ and fondue's place of origin—Europe. In particular, the design will utilize materials, color schemes, and inspiration from fire and ice, representing the heating and cooling of the cuisine. The design will utilize pale blues and an angular floor plan to mimic ice in nature, and vibrant reds, oranges, and textured surfaces to mimic fire. There will be a variety of intimate dining options in addition to the bar to support more personal experiences. Overall, the design will attract the targeted audience through effective lighting, stimulating textures, and sleek materials.

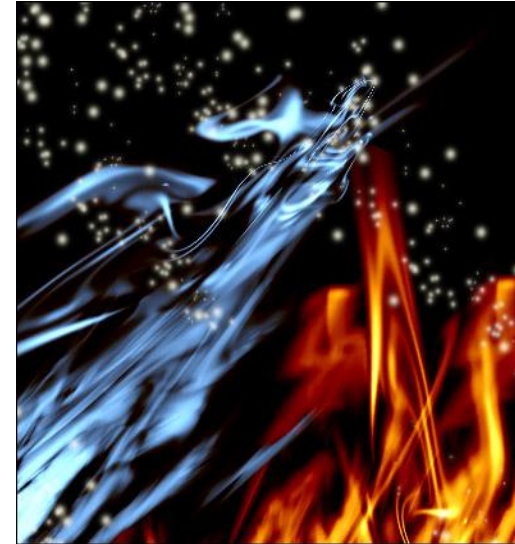

Materials and FF&E

3 Form Sculptural Accents



Table Series



3Form Column Lighting and Textured Surfaces



Modular Arts Textured Wall

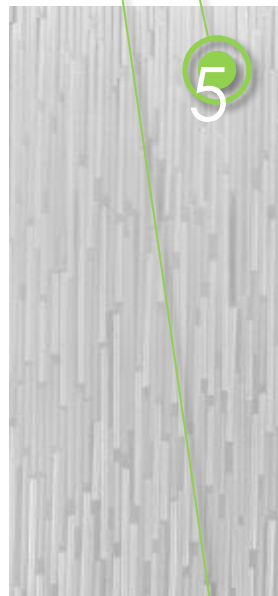

3 Form Stylized Lighting



Hardwood Flooring



Seating



Pendant Lighting

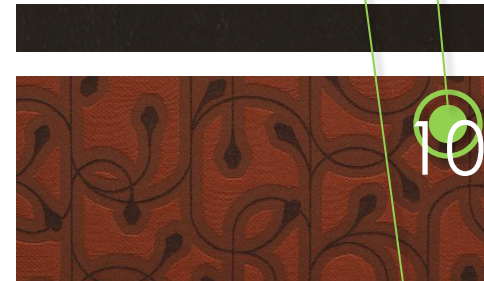

Seating



3Form Textured Surface

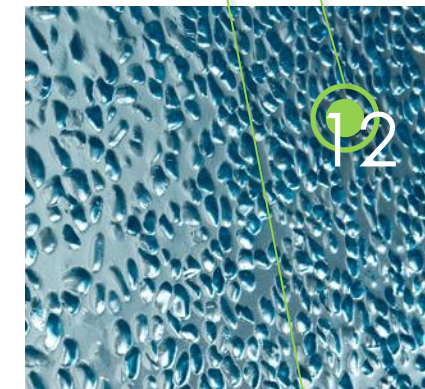

Barstool



Hardwood Flooring



Seating

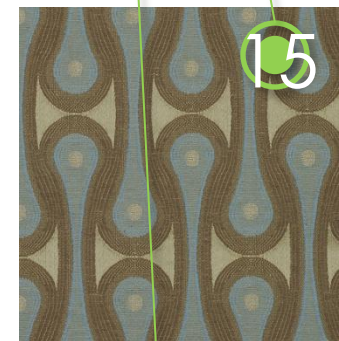

Seating

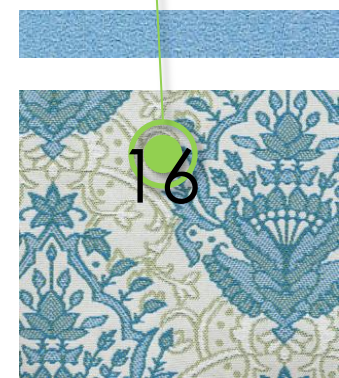

1

3

5

7

9

12

14

2

4

6

8

10

11

13

15

16

Floor Plan: First Floor

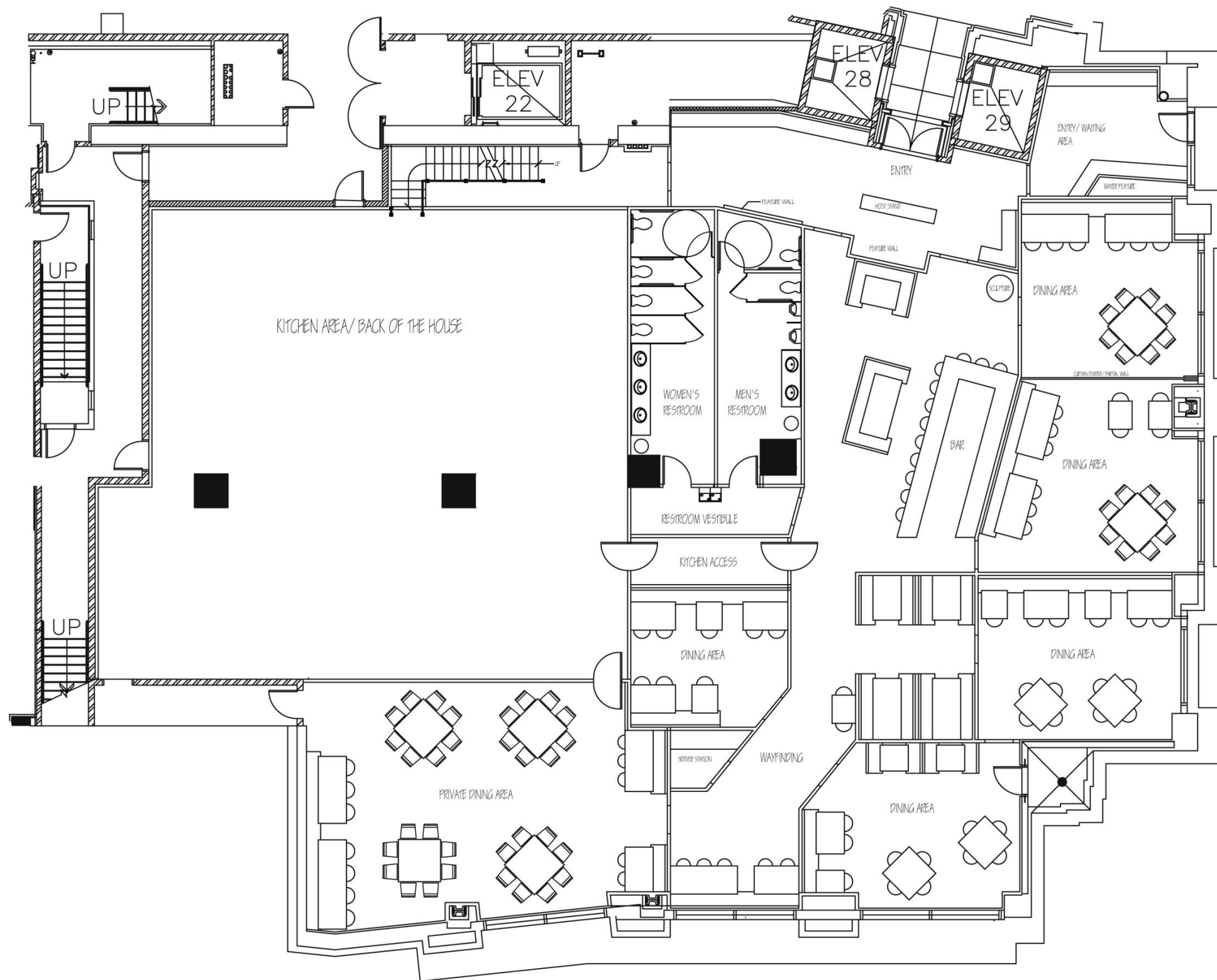

Floor Plan: Second Floor

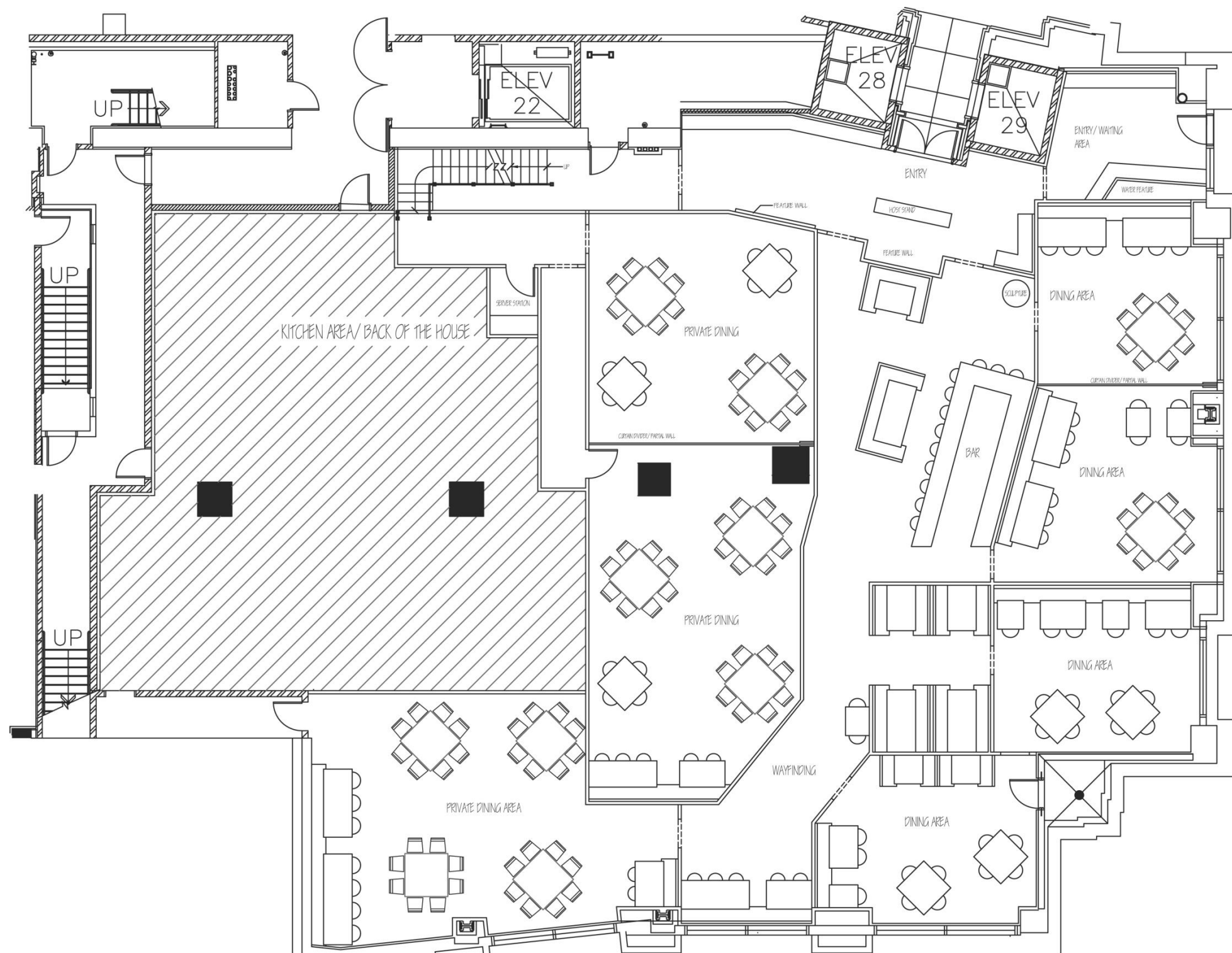

Lighting Plan and Legend: First Floor

LIGHTING LEGEND	
EYEBALL RECESSED	⊙
RECESSED LIGHTING	○
SMALL PENDANT	○
LARGE PENDANT	○

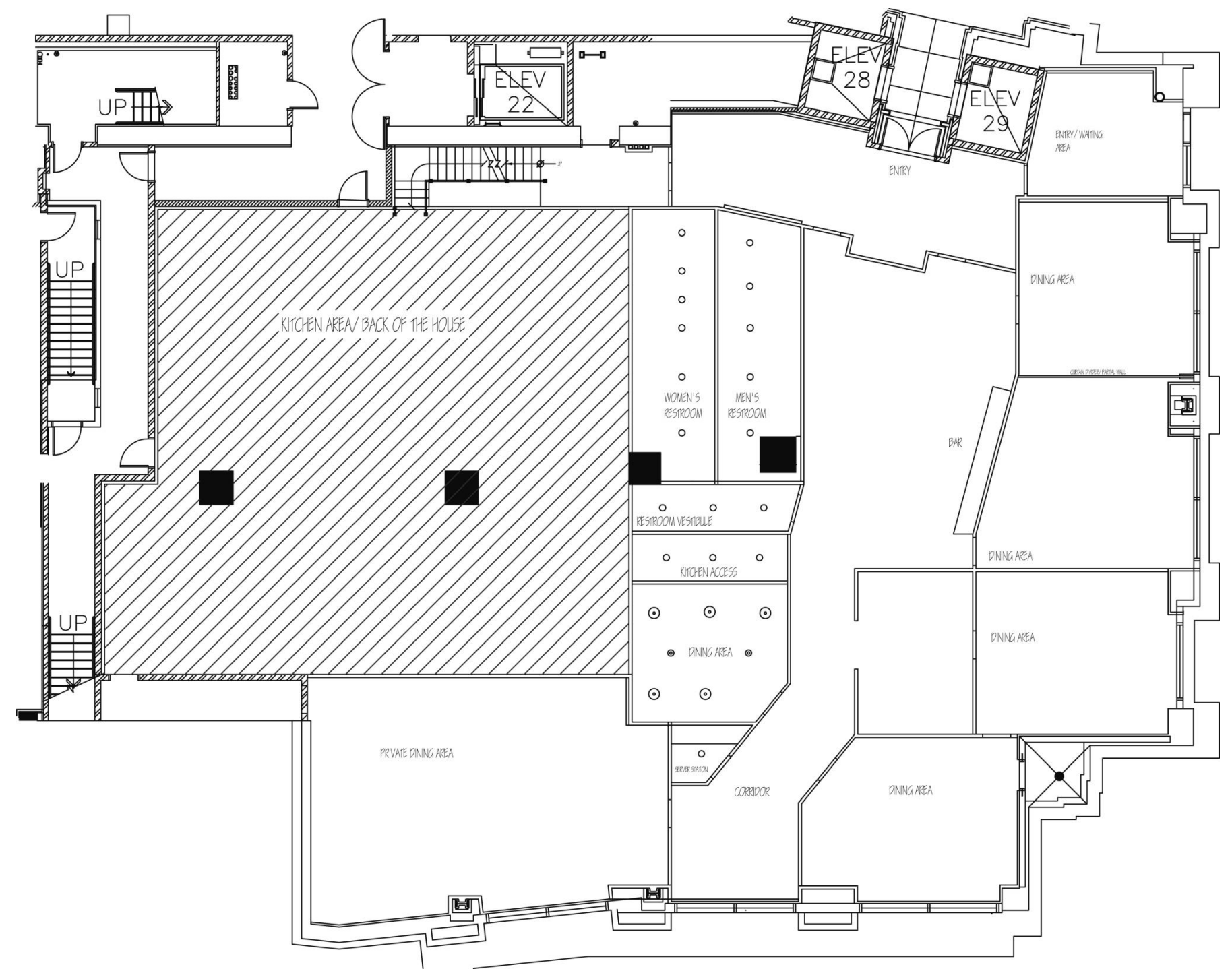

Lighting Plan and Legend: Second Floor

LIGHTING LEGEND	
EYEBALL RECESSED	⊙
RECESSED LIGHTING	○
SMALL PENDANT	⊙
LARGE PENDANT	○

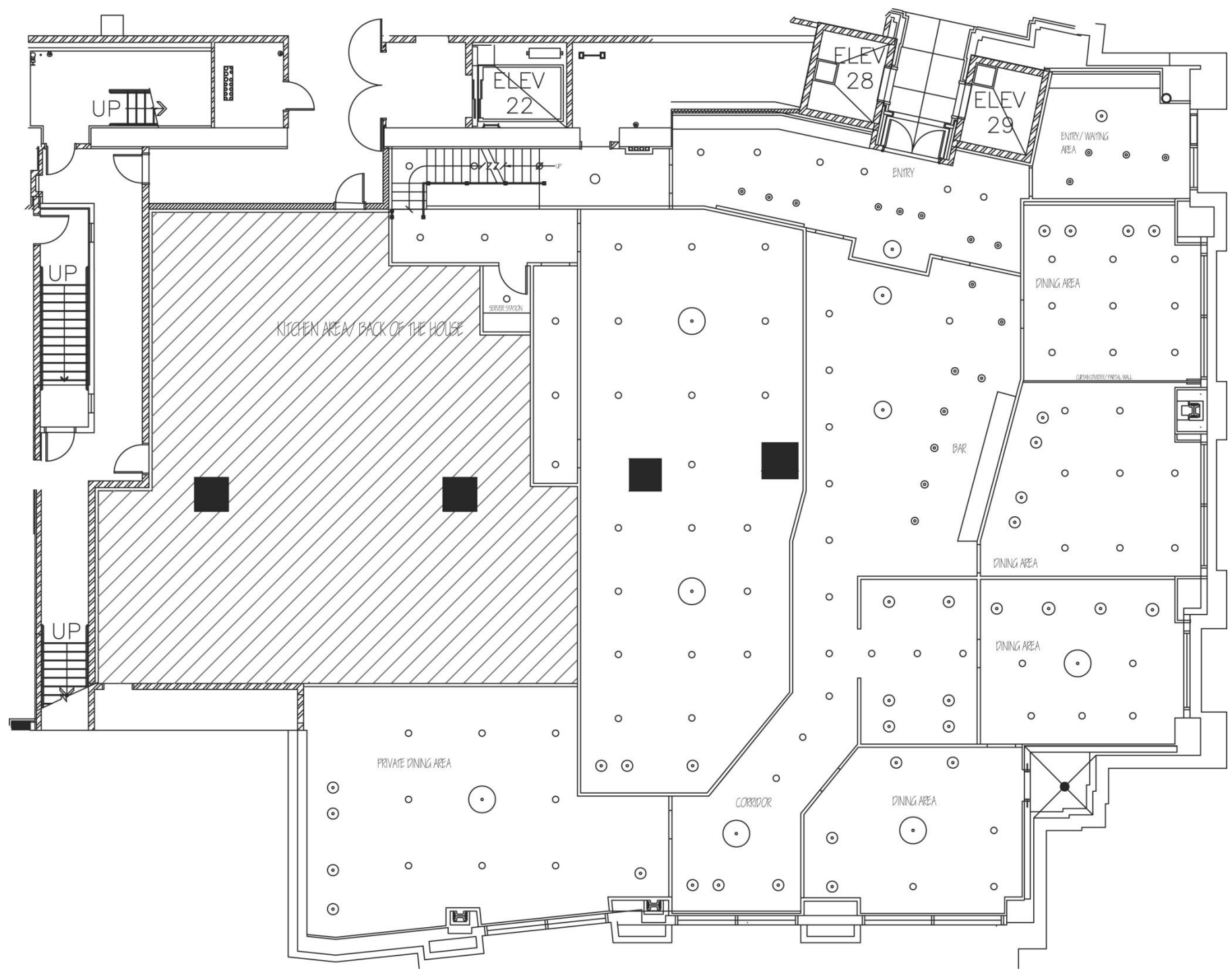

Millwork Details

Front Bar: Section View

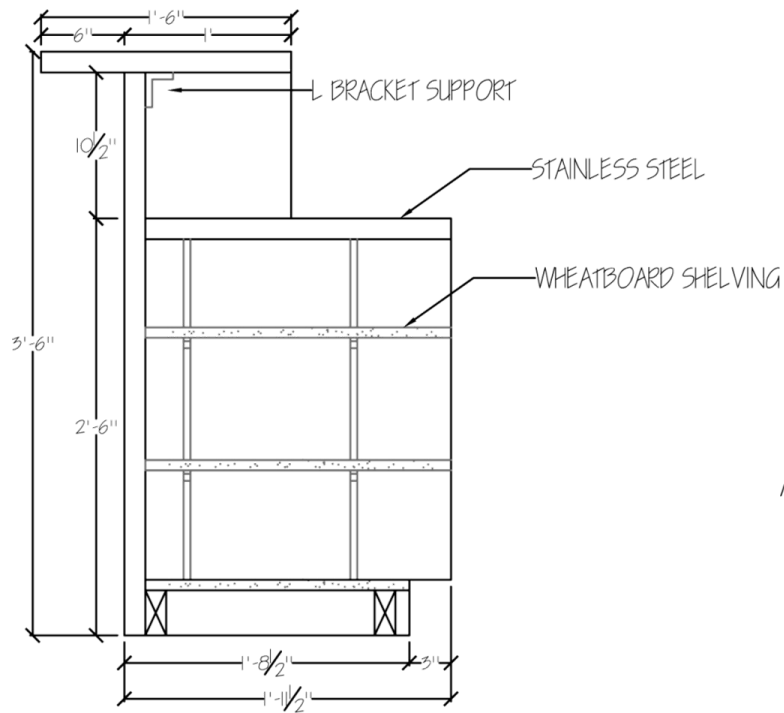

Host Stand: Side View

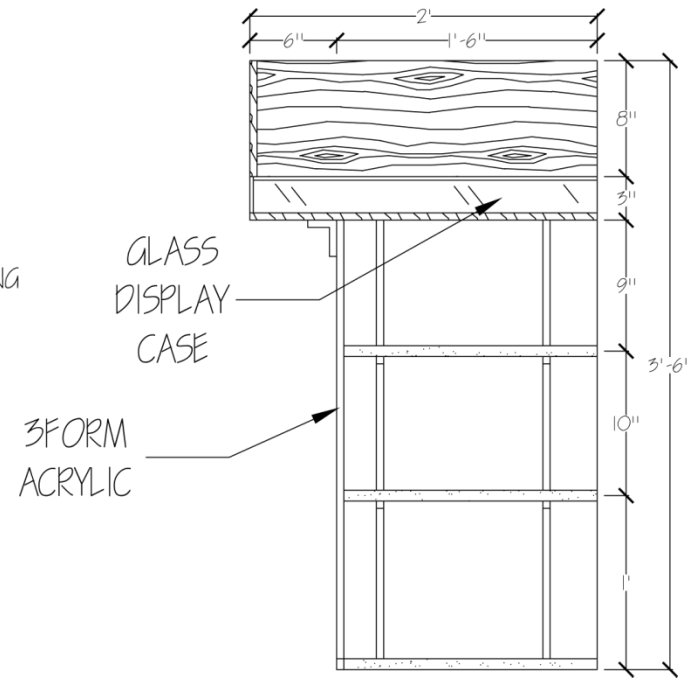

Host Stand: Front View

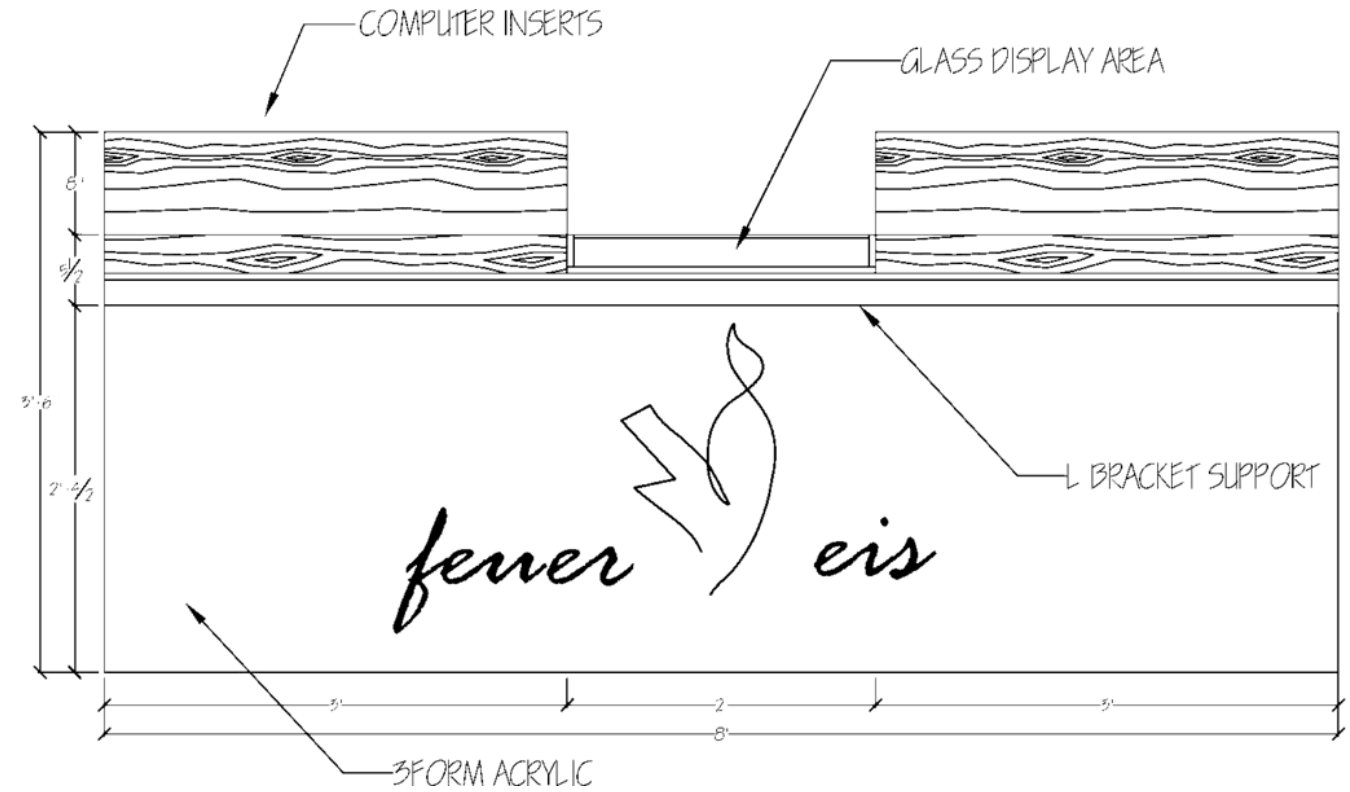

Front Bar: Front View

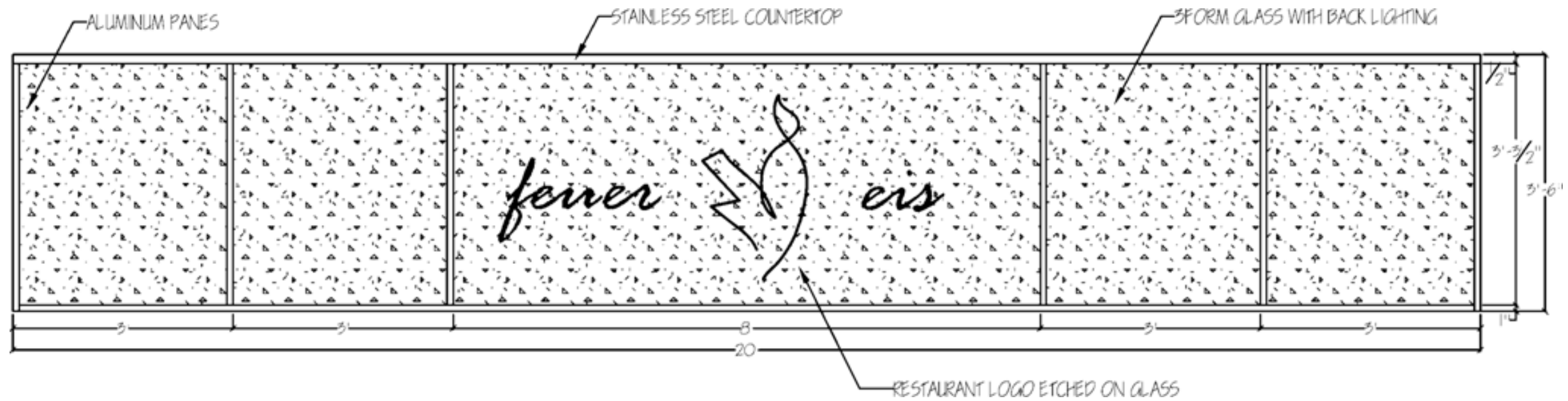

Perspective: Bar Dining Area

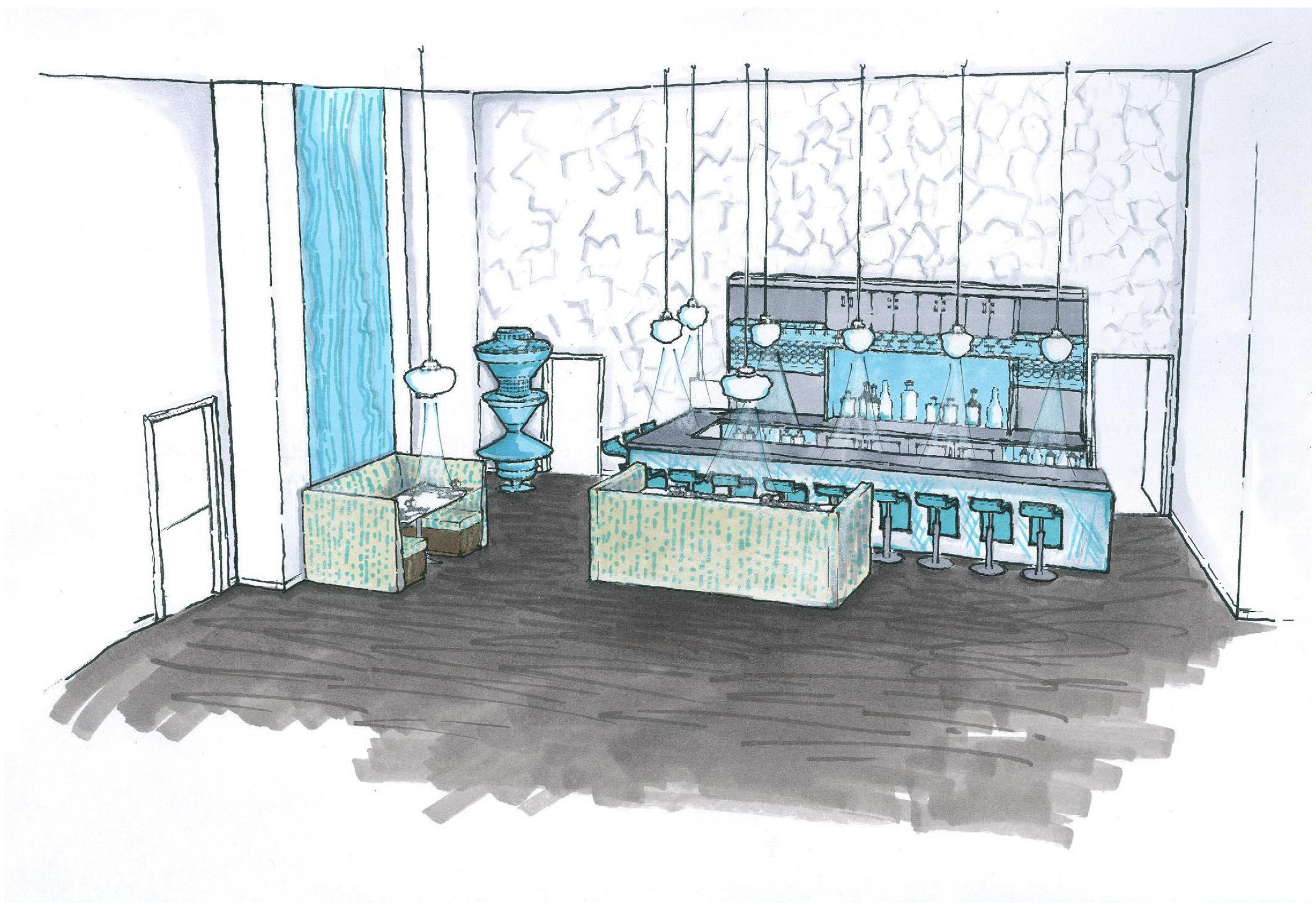

Perspective: Downstairs Dining Area

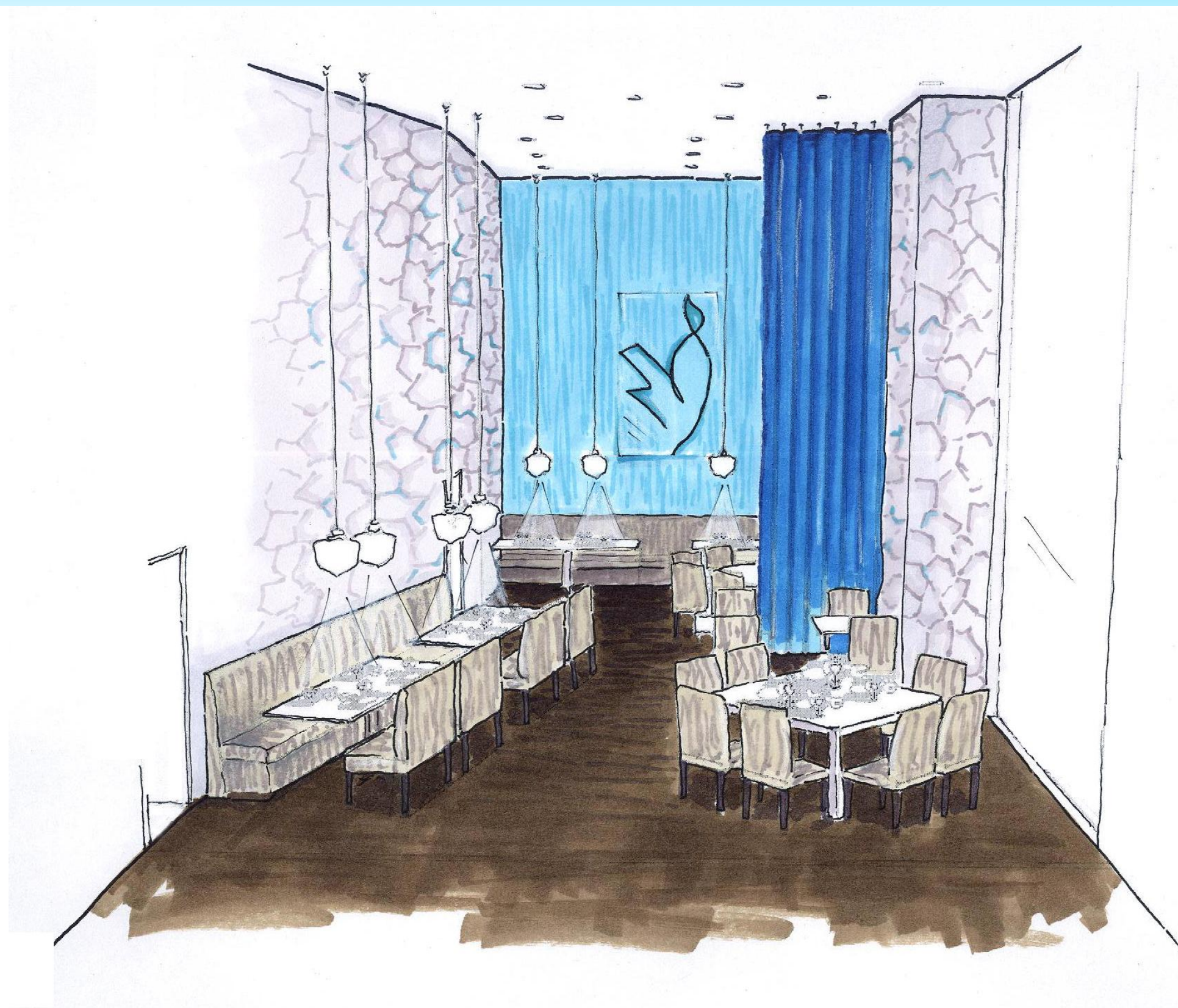

Perspective: Upstairs Private Dining Area

